

MESSINA

Hängeleuchte linear / pendant linear

IP 20  

Hängeleuchte aus stranggepresstem, eloxiertem Aluminiumprofil mit seitlicher Acryl-Abdeckung, inkl. werkzeuglos höhenverstellbarer Seilaufhängung und Einspeisung. Optikvarianten: BAP-Raster 60° oder Opal-Diffusor (separat ordern).

Luminaire made of anodised aluminium extrusion with acrylic side cover, suspension and power feed height toolless adjustable. Optional: 60° louvre or opal diffuser.

Apparecchio in estruso di alluminio anodizzato con pareti laterali in acrilico. Sospensione e alimentazione regolabili in altezza senza attrezzi. Opzionale: dark-light 60° o diffusore opale.

Appareil en aluminium extrudé anodisé, avec parois latérales en acrylique. Les suspensions et l'alimentation sont réglables en hauteur sans outillage. Optionnel: dark-light 60° ou diffuseur opale.

En aluminio extruido anodizado, con paredes laterales en acrílico. Las suspensiones y l'alimentación soy regulable en altura sin herramienta. Opcional: dark-light 60° o difusor ópala.

1 x T16 · G5 · 230V · 21/39W Multiwatt · EVG

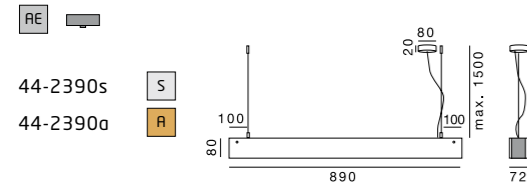

44-2390s
44-2390a



1 x T16 · G5 · 230V · 28/54W Multiwatt · EVG

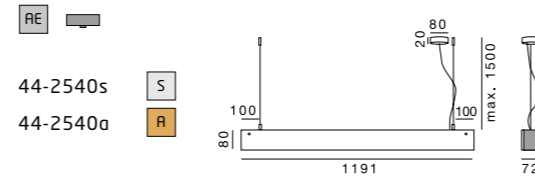

44-2540s
44-2540a

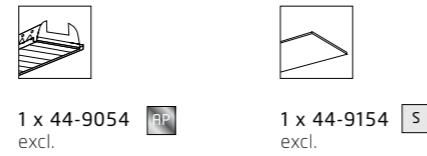

1 x T16 · G5 · 230V · 35/49/80W Multiwatt · EVG

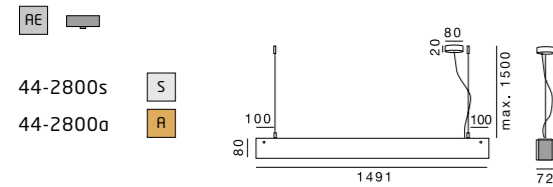

44-2800s
44-2800a



2 x 1x T16 · G5 · 230V · 21/39W Multiwatt · EVG

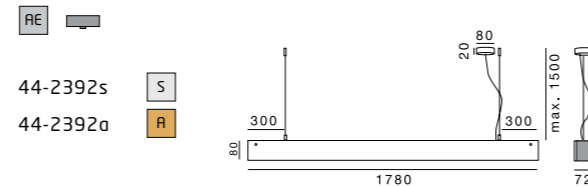

44-2392s
44-2392a



2 x 1x T16 · G5 · 230V · 28/54W Multiwatt · EVG

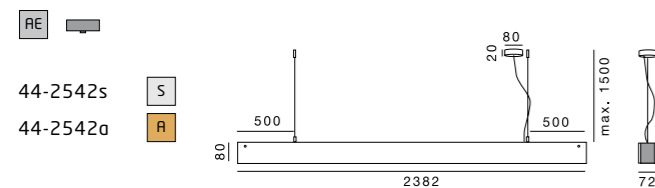

44-2542s
44-2542a

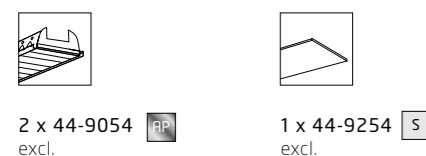

Dimmbare Versionen: siehe Preisliste
Dimmable versions: see price list

Bestellbeispiel / Order example: 44-XXXXad = analog dimm. 1 - 10V
44-XXXXddd = digital dimm. dali / switchDIM



MESSINA

Hängeleuchte quadratisch / pendant square

IP 20  

Hängeleuchte aus stranggepresstem, eloxiertem Aluminiumprofil mit seitlicher Acrylabdeckung, inkl. werkzeuglos höhenverstellbarer Seilaufhängung und Einspeisung. Optikvarianten: BRP-Raster 60° oder Opaldiffusor.

Luminaire made of anodised aluminium extrusion with acrylic side cover, suspension and power feed height toolless adjustable. Optional: 60° louvre or opal diffuser.

Apparecchio in estruso di alluminio anodizzato con pareti laterali in acrilico. Sospensione e alimentazione regolabili in altezza senza attrezzi. Opzionale: dark-light 60° o diffusore opale.

Appareil en aluminium extrudé anodisé, avec parois latéral en acrylique. Les suspensions et l'alimentation sont réglable en hauteur sans outillage. Optionnel: dark-light 60° ou diffuseur opale.

En aluminio extruido anodizado, con paredes laterales en acrílico. Las suspensiones y la alimentación son regulables en altura sin herramienta. Opcional: dark-light 60° o difusor ópalo.



4 x 1x T16 · G5 · 230V · 14/24W Multiwatt · EVG

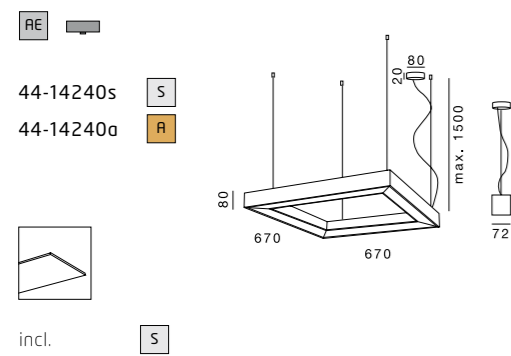

4 x 1x T16 · G5 · 230V · 14/24W Multiwatt · EVG

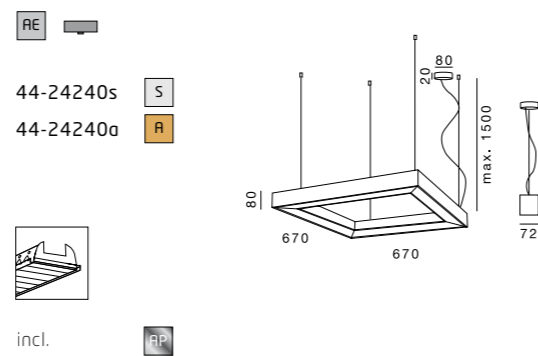

4 x 1x T16 · G5 · 230V · 28/54W Multiwatt · EVG

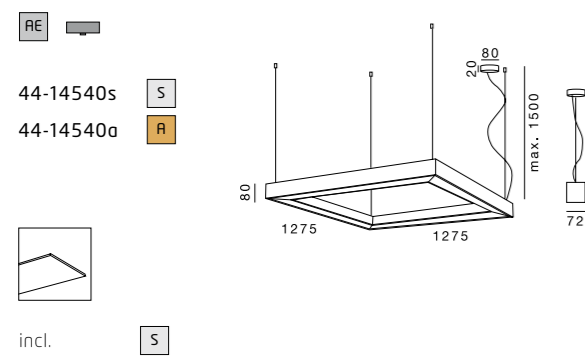

4 x 1x T16 · G5 · 230V · 28/54W Multiwatt · EVG

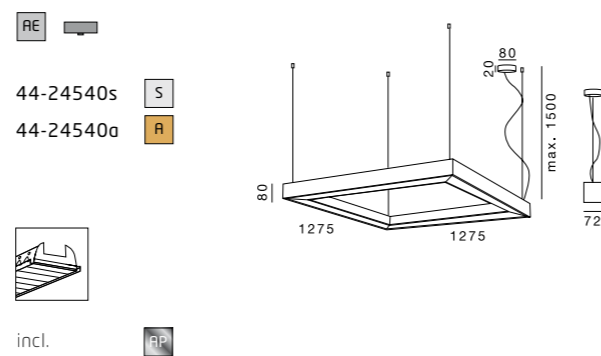

Dimmbare Versionen: siehe Preisliste
Dimmable versions: see price list

Bestellbeispiel / Order example: 44-XXXXad = analog dimm. 1 - 10V
44-XXXXddd = digital dimm. dali / switchDIM



MESSINA MIA

IP 20  

Beleuchtung, die zur Visitenkarte Ihres Unternehmens wird. Messina Mia bietet die Möglichkeit, durch Anbringung von Logos, Slogans oder anderen firmenspezifischen Informationen nachhaltige Effekte in der Imagebildung zu schaffen. Gestalten Sie mit Messina Mia Ihre ganz individuelle Beleuchtung!

Lighting which becomes a part of the company's business card. Messina Mia gives you the opportunity of sustainable effects in building up your company image especially at the point of sale. Create your individual lighting with placing identifying symbols like company logo and slogan on the diffuser.

L'illuminazione che diventa il biglietto da visita della Vostra azienda. Messina Mia Vi da la possibilità di apportare il Vs logo, slogan o altri messaggi per la Vostra clientela. Create la Vostra illuminazione personalizzata.

L'illumination qui devient la carte de visite de votre entreprise. Messina Mia vous donne la possibilité de placer votre logo, slogan ou des messages particulières pour votre clients. Créez votre illumination personnalisée.

La iluminación que se puede convertir en la tarjeta de visita de vuestra empresa. Messina Mia os da la posibilidad de poner vuestro logo, eslogan o otro mensaje para vuestros clientes. Se puede crear vuestra propia iluminación.



44-mia1i Klebefolie Digitaldruck innen / adhesive film digital print inside

zur Befestigung auf der Innenseite der Acrylabdeckung.

to be affixed on the inside of the acrylic diffuser.

da applicare all'interno del diffusore in acrilico.

à appliquer à l'intérieur du diffuseur.

a ponerse a l' interior del difusor satinado.

44-mia1a Klebefolie Digitaldruck aussen / adhesive film digital print outside

zur Befestigung auf der Aussenseite der Acrylabdeckung.

to be affixed on the outside of the acrylic diffuser.

da applicare all'esterno del diffusore in acrilico.

à appliquer à l'extérieur du diffuseur.

a ponerse a l' exterior del difusor satinado.



design: INHOUSE

MESSINA

Wand- Deckenleuchte linear / wall- ceiling luminaire linear

IP 20  

Wandleuchte aus stranggepresstem, eloxiertem Aluminiumprofil mit seitlicher Acrylabdeckung, inkl. Opaloptik.

Luminaire made of anodised aluminium extrusion with acrylic side cover, opal diffuser included.

Apparecchio in estruso di alluminio anodizzato con pareti laterali in acrilico, diffusore opale incluso.

Appareil en aluminium extrudé anodisé, avec parois latéral en acrylique, diffuseur opale inclus.

En aluminio extruido anodizado, con paredes laterales en acrílico, difusor ópalo incluido.

1 x TC-L · 2G11 · 230V · 24W · EVG

44-1230s

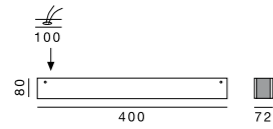

incl.



MESSINA

Wand- Deckenleuchte linear / wall- ceiling luminaire linear

IP 20  

Wand- Deckenleuchte aus stranggepresstem, eloxiertem Aluminiumprofil mit seitlicher Acrylglasabdeckung. Optikvarianten: BAP-Raster 60° oder Opaldiffusor (separat ordern).

Luminaire made of anodised aluminium extrusion, with acrylic side cover. Optional: 60° louvre or opal diffuser.

Apparecchio in estruso di alluminio anodizzato con pareti laterali in acrilico. Opzionale: dark-light 60° o diffusore opale.

Appareil en aluminium extrudé anodisé, avec parois latéral en acrylique. Optionnel: dark-light 60° ou diffuseur opale.

En aluminio extruido anodizado, con paredes laterales en acrílico. Opcional: dark-light 60° o difusor ópalo.



1 x T16 · G5 · 230V · 14/24W Multiwatt · EVG

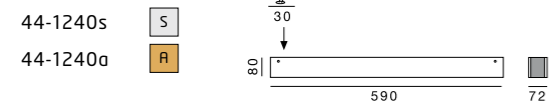

1 x T16 · G5 · 230V · 21/39W Multiwatt · EVG

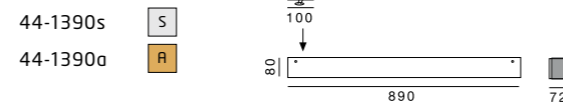

1 x T16 · G5 · 230V · 28/54W Multiwatt · EVG

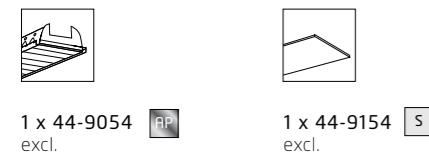
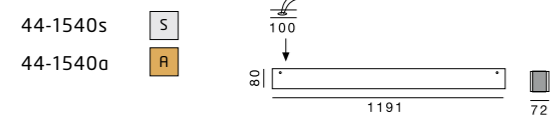

1 x T16 · G5 · 230V · 35/49/80W Multiwatt · EVG

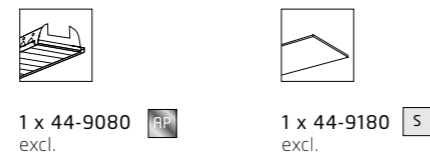
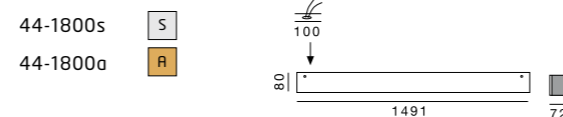

2 x 1x T16 · G5 · 230V · 21/39W Multiwatt · EVG

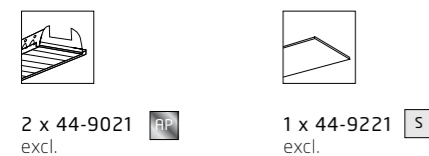
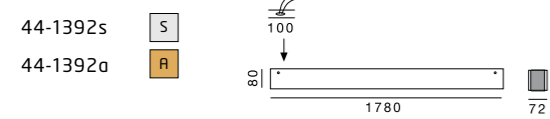

2 x 1x T16 · G5 · 230V · 28/54W Multiwatt · EVG

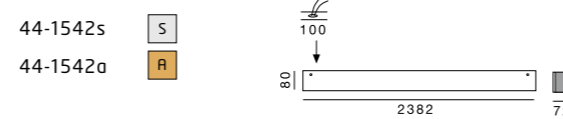

Dimmbare Versionen: siehe Preisliste
Dimmable versions: see price list

Bestellbeispiel / Order example: 44-XXXXad = analog dimm. 1 - 10V
44-XXXXddd = digital dimm. dali / switchDIM



MESSINA

Wand- Deckenleuchte quadratisch / wall- ceiling luminaire square

IP 20 

Wand- Deckenleuchte aus stranggepresstem, eloxiertem Aluminiumprofil mit seitlicher Acrylabdeckung. Optikvarianten: BAP-Raster 60° oder Opaldiffusor.

Luminaire made of anodised aluminium extrusion, with acrylic side cover. Optional: 60° louvre or opal diffuser.

Apparechio in estruso di alluminio anodizzato con pareti laterali in acrilico. Opzionale: dark-light 60° o diffusore opale.

Appareil en aluminium extrudé anodisé, avec parois latéral en acrylique. Optionnel: dark-light 60° ou diffuseur opale.

En aluminio extruido anodizado, con paredes laterales en acrílico. Opcional: dark-light 60° o difusor ópalo.



4 x 1x T16 · G5 · 230V · 14/24W Multiwatt · EVG

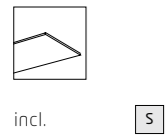
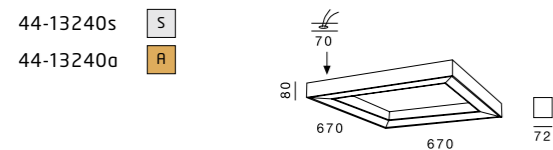

4 x 1x T16 · G5 · 230V · 14/24W Multiwatt · EVG

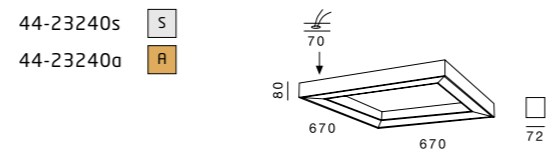

4 x 1x T16 · G5 · 230V · 28/54W Multiwatt · EVG

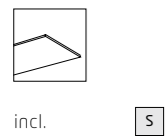
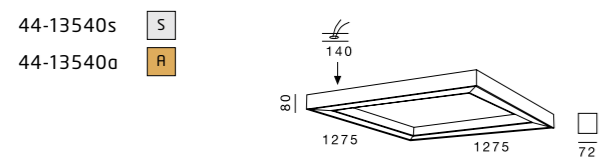

4 x 1x T16 · G5 · 230V · 28/54W Multiwatt · EVG

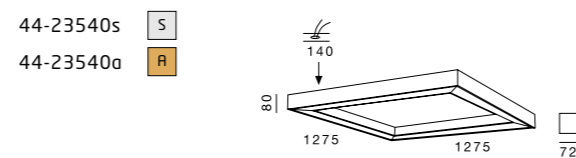

Dimmbare Versionen: siehe Preisliste
Dimmable versions: see price list

Bestellbeispiel / Order example: 44-XXXXad = analog dimm. 1 - 10V
44-XXXXddd = digital dimm. dali / switchDIM

MESSINA Systemhängeleuchte linear / system pendant linear

IP 20  

Systemleuchte aus strang-
gepresstem, eloxiertem
Aluminiumprofil mit seitlicher
Acrylabdeckung, 3x1mm² Durch-
gangsverdrahtung, System-Zube-
hör Seite 118 (separat ordern).
Optikvarianten: BAP-Raster
60° oder Opaldiffusor (separat
ordern).

Made of anodised aluminium
extrusion, with acrylic side cover.
3x1mm² through-wired, system
parts (page 118). Optional: 60°
louvre or opal diffuser.



Apparecchi da sistema in estruso
di alluminio anodizzato con pareti
laterali in acrilico. Cablato con
3x1mm², componenti sistema a
pagina 118. Opzionale: dark-light
60° o diffusore opale.

Appareil en aluminium extrudé
anodisé, avec parois latéral en
acrylique. Cablé continu avec
3x1mm². Composants du système
à la page 118. Optionnel: dark-
light 60° ou diffuseur opale.

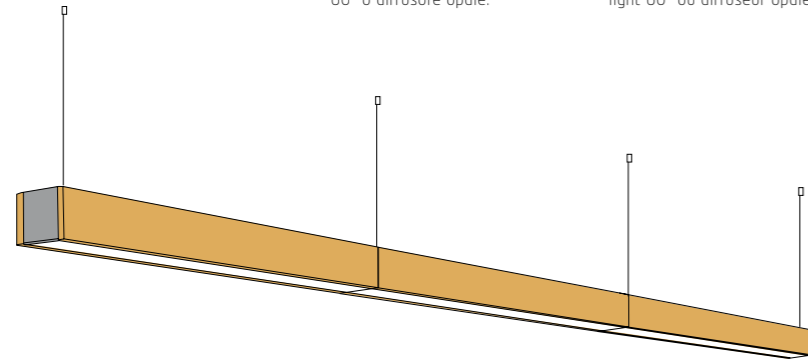
En aluminio extruido anodizado,
con paredes laterales en acrílico.
Cableado con 3x1mm². Compone-
ntes para sistema a pagina 118.
Opcional: dark-light 60° o difusor
ópalo.



1 x T16 · G5 · 230V · 14/24W Multiwatt · EVG

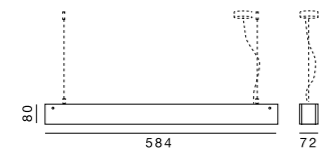

44-4240s 
44-4240a 





1 x 44-9024 
excl.

1 x 44-9124 
excl.

1 x T16 · G5 · 230V · 21/39W Multiwatt · EVG

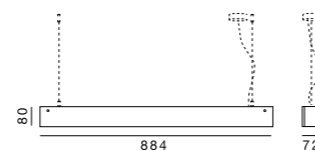

44-4390s 
44-4390a 





1 x 44-9021 
excl.

1 x 44-9121 
excl.

1 x T16 · G5 · 230V · 28/54W Multiwatt · EVG

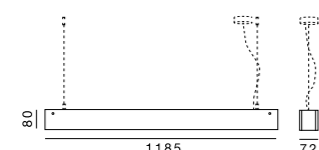

44-4540s 
44-4540a 





1 x 44-9054 
excl.

1 x 44-9154 
excl.

1 x T16 · G5 · 230V · 35/49/80W Multiwatt · EVG

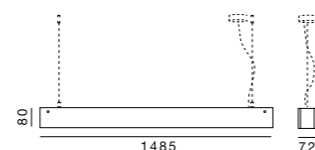

44-4800s 
44-4800a 





1 x 44-9080 
excl.

1 x 44-9180 
excl.

2 x 1x T16 · G5 · 230V · 21/39W Multiwatt · EVG

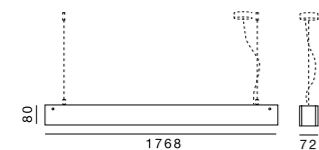

44-4392s 
44-4392a 





2 x 44-9021 
excl.

1 x 44-9221 
excl.

2 x 1x T16 · G5 · 230V · 28/54W Multiwatt · EVG

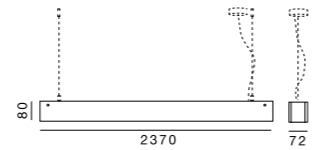
44-4542s 
44-4542a 



2 x 44-9054 
excl.

1 x 44-9254 
excl.

Dimmbare Versionen: siehe Preisliste

Dimmable versions: see price list

Bestellbeispiel / Order example: 44-XXXXad = analog dimm. 1 - 10V

44-XXXXddd = digital dimm. dali / switchDIM



MESSINA Systemhängeleuchte / system pendant

IP 20

Systemleuchte aus strang-gepresstem, eloxiertem Aluminiumprofil mit seitlicher Acrylabdeckung, 3x1mm² Durchgangsverdrahtung, System-Zubehör Seite 118 (separat ordern), Optikvarianten: BAP-Raster 60° oder Opaldiffusor (separat ordern).

Made of anodised aluminium extrusion, with acrylic side cover. 3x1mm² through-wired, system parts page 118. Optional: 60° louvre or opal diffuser.

Apparecchi da sistema in estruso di alluminio anodizzato con pareti laterali in acrilico. Cablato con 3x1mm², componenti sistema a pagina 118. Opzionale: dark-light 60° o diffusore opale.

Appareil en aluminium extrudé anodisé, avec parois latéral en acrylique. Câblé continu avec 3x1mm². Composants du système à la page 118. Optionnel: dark-light 60° ou diffuseur opale.

En aluminio extruido anodizado, con paredes laterales en acrílico. Cableado con 3x1mm². Componentes para sistema a pagina 118. Opcional: dark-light 60° o difusor ópalo.

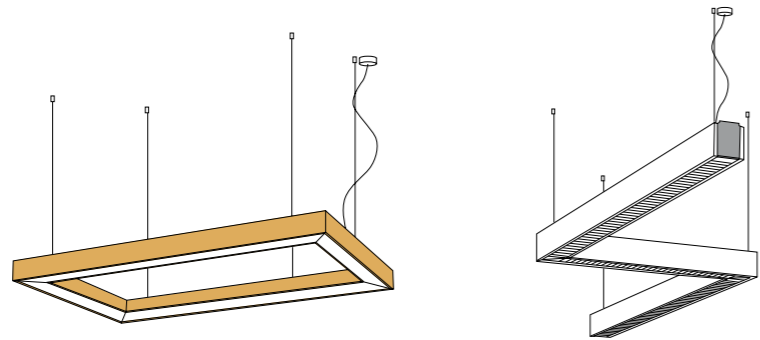

2 x 90° R + R

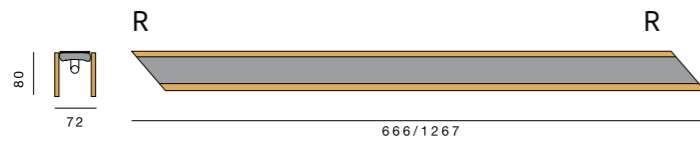

1 x T16 · G5 · 230V · 14/24W Multiwatt · EVG

44-4240rr90s L 666mm
44-4240rr90a L 666mm

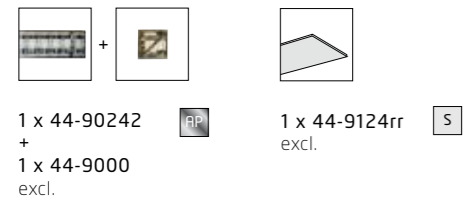

1 x T16 · G5 · 230V · 28/54W Multiwatt · EVG

44-4540rr90s L 1267mm
44-4540rr90a L 1267mm



2 x 90° L + L

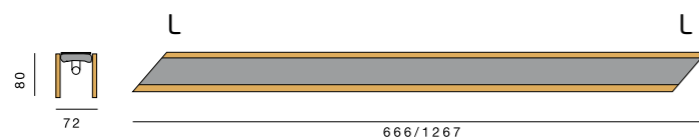

1 x T16 · G5 · 230V · 14/24W Multiwatt · EVG

44-4240ll90s L 666mm
44-4240ll90a L 666mm

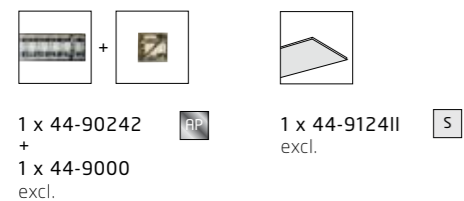

1 x T16 · G5 · 230V · 28/54W Multiwatt · EVG

44-4540ll90s L 1267mm
44-4540ll90a L 1267mm



1 x 90° R

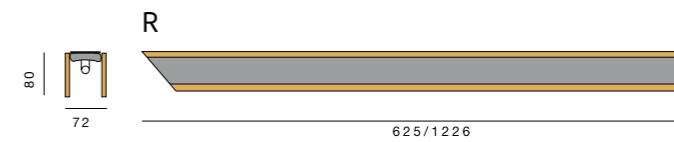

1 x T16 · G5 · 230V · 14/24W Multiwatt · EVG

44-4240r90s L 625mm
44-4240r90a L 625mm

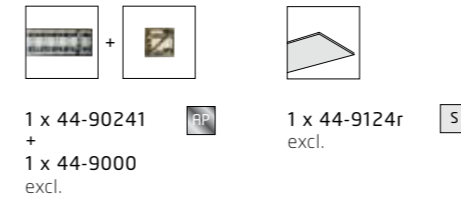

1 x T16 · G5 · 230V · 28/54W Multiwatt · EVG

44-4540r90s L 1226mm
44-4540r90a L 1226mm

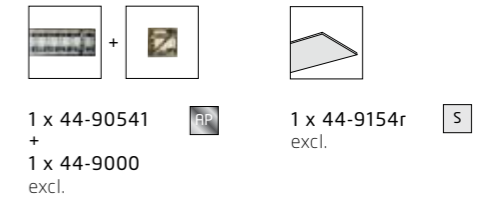

1 x 90° L

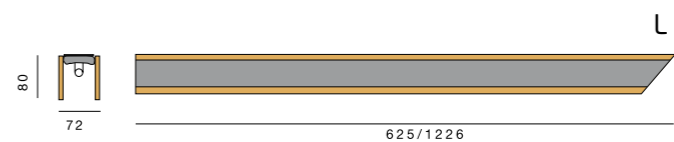

1 x T16 · G5 · 230V · 14/24W Multiwatt · EVG

44-4240l90s L 625mm
44-4240l90a L 625mm



1 x T16 · G5 · 230V · 28/54W Multiwatt · EVG

44-4540l90s L 1226mm
44-4540l90a L 1226mm

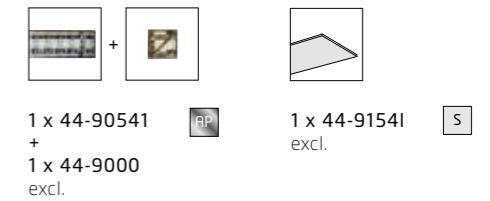

2 x 90° R + L

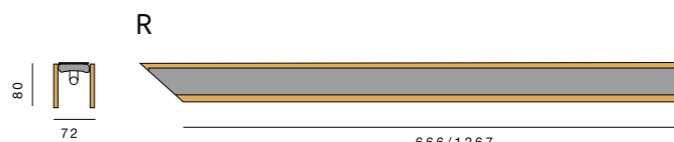

1 x T16 · G5 · 230V · 14/24W Multiwatt · EVG

44-4240rl90s L 666mm
44-4240rl90a L 666mm



1 x T16 · G5 · 230V · 28/54W Multiwatt · EVG

44-4540rl90s L 1267mm
44-4540rl90a L 1267mm



Dimmbare Versionen: siehe Preisliste
Dimmable versions: see price list

Bestellbeispiel / Order example: 44-XXXXad = analog dimm. 1 - 10V
44-XXXXddd = digital dimm. dali / switchDIM

MESSINA System Wand- Deckenleuchte linear / system wall- ceiling luminaire linear

IP 20   

Individuell planbare Systemleuchte aus stranggepresstem, eloxiertem Aluminiumprofil mit seitlicher Acrylabdeckung. 3x1mm² Durchgangsverdrahtung, System-Zubehör Seite 118 (separat ordern). Optikvarianten: BAP-Raster 60° oder Opaldiffusor (separat ordern)

Made of anodised aluminium extrusion, with acrylic side cover, designed for custom solutions. 3x1mm² through-wired, system parts (page 118). Optional: 60° louvre or opal diffuser.



Apparecchi da sistema in estruso di alluminio anodizzato con pareti laterali in acrilico. Per soluzioni personalizzate. Cablaggio continuo con 3x1mm², componenti sistema a pagina 118. Opzionale: dark-light 60° o diffusore opale.

Appareil en aluminium extrudé anodisé, avec parois latéral en acrylique. Pour solutions personnalisées, cable continu avec 3x1mm². Composants du système à la page 118. Optionnel: dark-light 60° ou diffuseur opale.

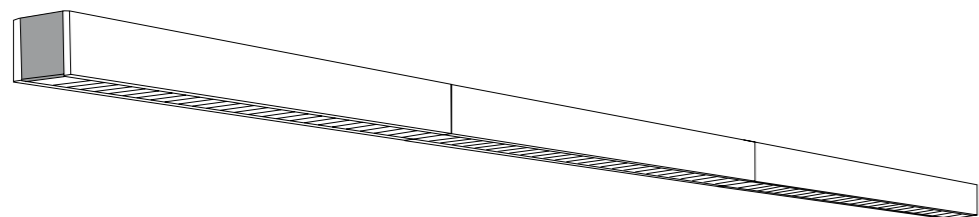

En aluminio extruido anodisado, con paredes laterales en acrílico. Para soluciones personalizadas. Cableado con 3x1mm². Componentes para sistema a pagina 118. Opcional: dark-light 60° o difusor ópalo.



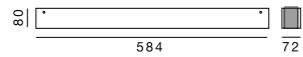

1 x T16 · G5 · 230V · 14/24W Multiwatt · EVG

44-3240s  
 44-3240a 





1 x 44-9024  excl.
 1 x 44-9124  excl.

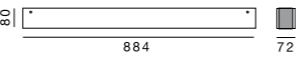

1 x T16 · G5 · 230V · 21/39W Multiwatt · EVG

44-3390s  
 44-3390a 





1 x 44-9021  excl.
 1 x 44-9121  excl.

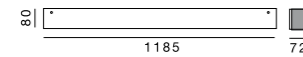

1 x T16 · G5 · 230V · 28/54W Multiwatt · EVG

44-3540s  
 44-3540a 





1 x 44-9054  excl.
 1 x 44-9154  excl.

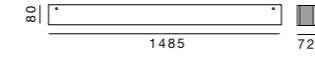

1 x T16 · G5 · 230V · 35/49/80W Multiwatt · EVG

44-3800s  
 44-3800a 





1 x 44-9080  excl.
 1 x 44-9180  excl.

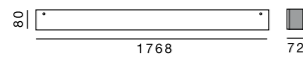

2 x 1x T16 · G5 · 230V · 21/39W Multiwatt · EVG

44-3392s  
 44-3392a 





2 x 44-9021  excl.
 1 x 44-9221  excl.

2 x 1x T16 · G5 · 230V · 28/54W Multiwatt · EVG

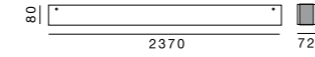
44-3542s  
 44-3542a 



2 x 44-9054  excl.
 1 x 44-9254  excl.

Dimmbare Versionen: siehe Preisliste
 Dimmable versions: see price list

Bestellbeispiel / Order example: 44-XXXXad = alalog dimm. 1 - 10V
 44-XXXXddd = digital dimm. dali / switchDIM



MESSINA

System Wand- Deckenleuchte / system wall- ceiling luminaire

IP 20   

Individuell planbare Systemleuchte aus stranggepresstem, exoxiertem Aluminiumprofil mit seitlicher Acrylabdeckung. 3x1mm² Durchgangsverdrahtung, System-Zubehör Seite 118 (separat ordern). Optikvarianten: BAP-Raster 60° oder Opaldiffusor (separat ordern).

Made of anodised aluminium extrusion, with acrylic side cover. 3x1mm² through-wired, system parts (page 118). Optional: 60° louvre or opal diffuser.

Apparecchi da sistema in estruso di alluminio anodizzato con pareti laterali in acrilico. Per soluzioni personalizzate. Cablaggio continuo con 3x1mm², componenti sistema a pagina 118. Opzionale: dark-light 60° o diffusore opale.

Appareil en aluminium extrudé anodisé, avec parois latéral en acrylique. Pour solutions personnalisées, câblé continu avec 3x1mm². Composants du système à la page 118. Optionnel: dark-light 60° ou diffuseur opale.

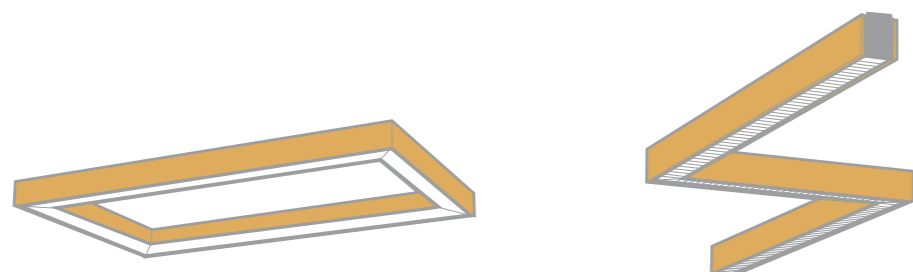

En aluminio extruido anodizado, con paredes laterales en acrílico. Para soluciones personalizadas. Cableado con 3x1mm². Componentes para sistema a pagina 118. Opcional: dark-light 60° o difusor ópalo.

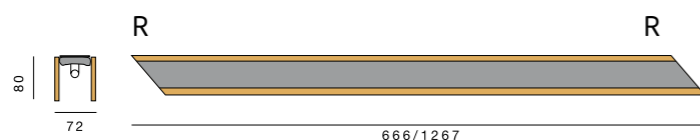

2 x 90° R + R



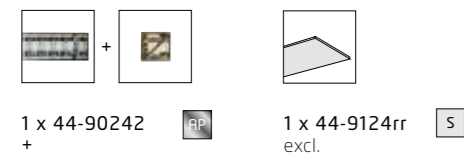

1 x T16 · G5 · 230V · 14/24W Multiwatt · EVG

44-3240rr90s  L 666mm
44-3240rr90a  L 666mm



1 x 44-90242  +
1 x 44-9000
excl. 1 x 44-9124rr  excl.

1 x T16 · G5 · 230V · 28/54W Multiwatt · EVG

44-3540rr90s  L 1267mm
44-3540rr90a  L 1267mm

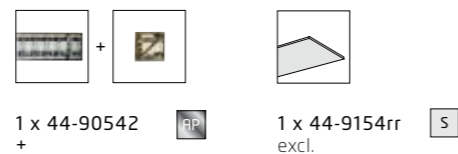

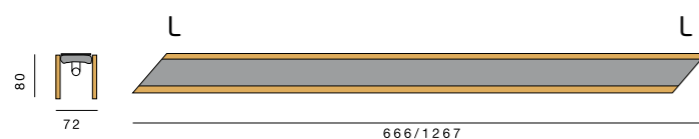

1 x 44-90542  +
1 x 44-9000
excl. 1 x 44-9154rr  excl.

2 x 90° L + L



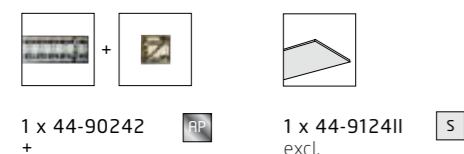

1 x T16 · G5 · 230V · 14/24W Multiwatt · EVG

44-3240ll90s  L 666mm
44-3240ll90a  L 666mm





1 x 44-90242  +
1 x 44-9000
excl. 1 x 44-9124ll  excl.

1 x T16 · G5 · 230V · 28/54W Multiwatt · EVG

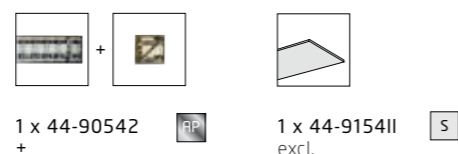
44-3540ll90s  L 1267mm
44-3540ll90a  L 1267mm



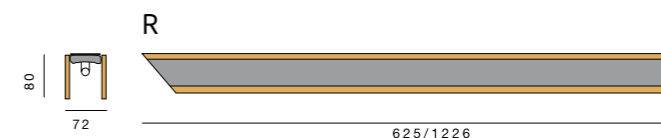

1 x 44-90542  +
1 x 44-9000
excl. 1 x 44-9154ll  excl.

1 x 90° R





1 x T16 · G5 · 230V · 14/24W Multiwatt · EVG

44-3240r90s  L 625mm
44-3240r90a  L 625mm



1 x 44-90241  +
1 x 44-9000
excl. 1 x 44-9124r  excl.

1 x T16 · G5 · 230V · 28/54W Multiwatt · EVG

44-3540r90s  L 1226mm
44-3540r90a  L 1226mm



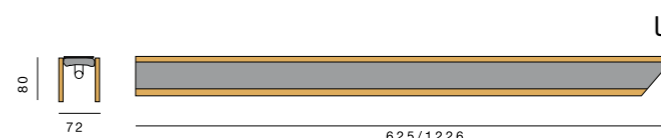

1 x 44-90541  +
1 x 44-9000
excl. 1 x 44-9154r  excl.

1 x 90° L





1 x T16 · G5 · 230V · 14/24W Multiwatt · EVG

44-3240l90s  L 625mm
44-3240l90a  L 625mm



1 x 44-90241  +
1 x 44-9000
excl. 1 x 44-9124l  excl.

1 x T16 · G5 · 230V · 28/54W Multiwatt · EVG

44-3540l90s  L 1226mm
44-3540l90a  L 1226mm



1 x 44-90541  +
1 x 44-9000
excl. 1 x 44-9154l  excl.

2 x 90° R + L

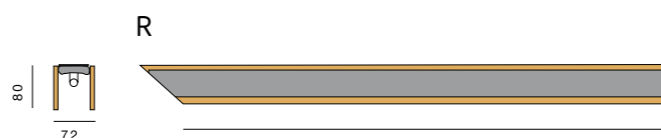

1 x T16 · G5 · 230V · 14/24W Multiwatt · EVG

44-3240rl90s  L 666mm
44-3240rl90a  L 666mm



1 x 44-90242  +
1 x 44-9000
excl. 1 x 44-9124rl  excl.

1 x T16 · G5 · 230V · 28/54W Multiwatt · EVG

44-3540rl90s  L 1267mm
44-3540rl90a  L 1267mm



1 x 44-90542  +
1 x 44-9000
excl. 1 x 44-9154rl  excl.

Dimmbare Versionen: siehe Preisliste

Dimmable versions: see price list

Bestellbeispiel / Order example: 44-XXXXad = alalog dimm. 1 - 10V

44-XXXXddd = digital dimm. dali / switchDIM

Endstückabdeckung; für Systemhänge und Wand-/ Deckenleuchten

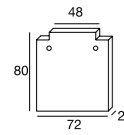

44-5099 

End piece cover; for pendant and wall / ceiling system luminaires



Testata finale per sistemi in sospensione ed a soffitto o parete

Embout; pour système de suspension et applique/plafonnier

Tapa final; por sistema de suspensión y applique/plafón

Verbindungsglasche linear; innenliegend; für Systemhänge und Wand-/ Deckenleuchten

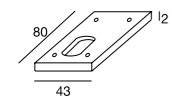

44-5001 

Linear connector; iside; for pendant and wall-/ ceiling system luminaires





Connettore lineare per sistemi in sospensione ed a soffitto o parete

Raccord en ligne pour système de suspension et applique/plafonnier

Junta lineal por sistema de suspensión y applique/plafón

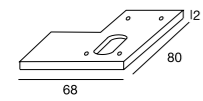
Verbindungsglasche 90°; innenliegend; für Systemhänge und Wand-/ Deckenleuchten



44-5002 

Linear connector 90°; iside; for pendant and wall-/ ceiling system luminaires



Connettore a 90° interno per sistemi in sospensione ed a soffitto o parete

Raccord à 90° pour système de suspension et applique/plafonnier

Junta a 90° por sistema de suspensión y applique/plafón

Einspeisung; für Systemhängeleuchten

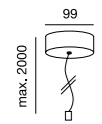

44-5010  3 x 1 mm²

44-5011  5 x 1 mm² (f. Dimm)

Power feed; for pendant system





Alimentazione per sistema a sospensione

Alimentation pour système de suspension

Alimentación por sistema de suspensión

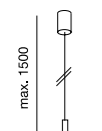
Einspeisung; für Systemhängeleuchten



44-5015 

Power feed; for pendant system



Alimentazione per sistema a sospensione

Alimentation pour système de suspension

Alimentación por sistema de suspensión



- 1.) make a drawing!
- 2.) note the watts you require
- 3.) position the arrows at the inner side of the angles, write "L" on the left side of the arrow, write "R" on the right side of the arrow (like in the example underneath)

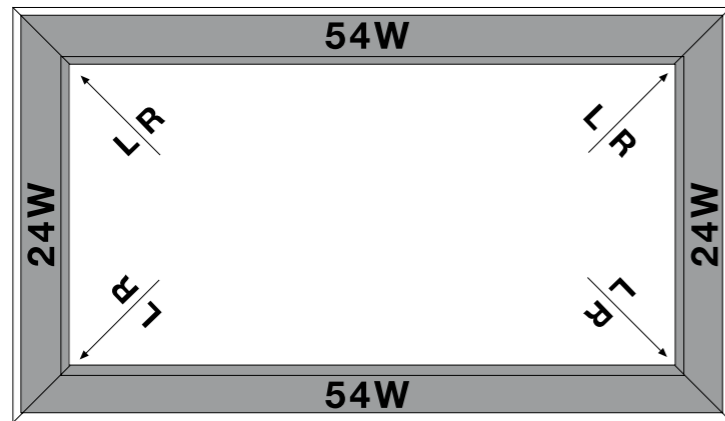

Order List:

- 2 x 44-4540r190s (system luminaire 54W)
- 2 x 44-9154rl (acryl cover)
- 2 x 44-4240r190s (system luminaire 24W)
- 2 x 44-9124rl (acryl cover)
- 4 x 44-5002 (linear connector 90°)
- 4 x 44-5015 (wire suspension)
- 1 x 44-5010 or 5011 (power feed)

