

# MILANO NOTTE

Eccetto Hängeleuchte / Eccetto pendant

IP 20 

Geradlinige, direktstrahlende Hängeleuchte aus eloxiertem, stranggepresstem Aluminiumprofil, inkl. werkzeuglos höhenverstellbarer Seilaufhängung und Einspeisung. Optikvarianten: BAP-Raster 60° oder Opaldiffusor (separat ordern).

Straight-forward luminaire made of anodised aluminium extrusion, suspension and power feed height toolless adjustable. Optional: 60° louvre or opal diffuser.



Apparecchio lineare in alluminio estruso anodizzato, Sospensione e alimentazione regolabili in altezza senza attrezzi. Opzionale: dark-light 60° o diffusore opale.

Appareil linéaire en aluminium extrudé anodisé, Les suspensions et l'alimentation sont réglable en hauteur sans outillage. Optionnel: dark-light 60° ou diffuseur opale.

Forma lineal en aluminio extruido anodizado. Las suspensiones y la alimentación son regulables en altura sin herramienta. Opcional: dark-light 60° o difusor ópalo.





BAP-Raster / darklight 60°

- 16-9021  1 x 21W
- 16-9024  1 x 24W
- 16-9054  1 x 54W



Opaldiffusor / Cover opal

- 16-9011  1 x 21W
- 16-9012  2 x 24W
- 16-9015  1 x 54W

1 x T16 · G5 · 230V · 21W · EVG

16-1111 

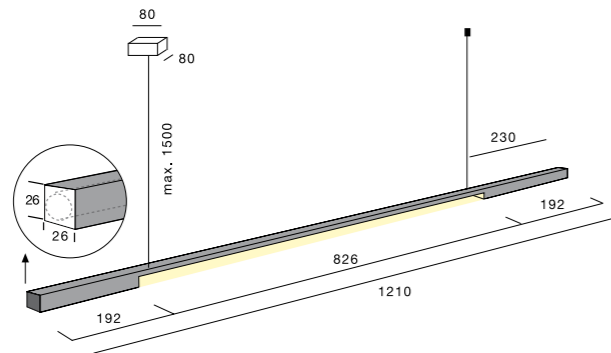

2 x T16 · G5 · 230V · 24W · EVG

16-1112 

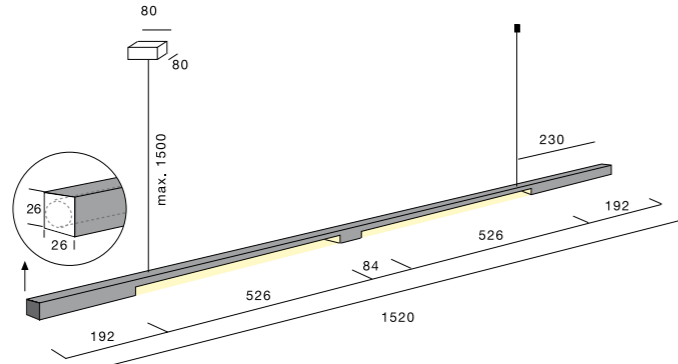

1 x T16 · G5 · 230V · 54W · EVG

16-1119 

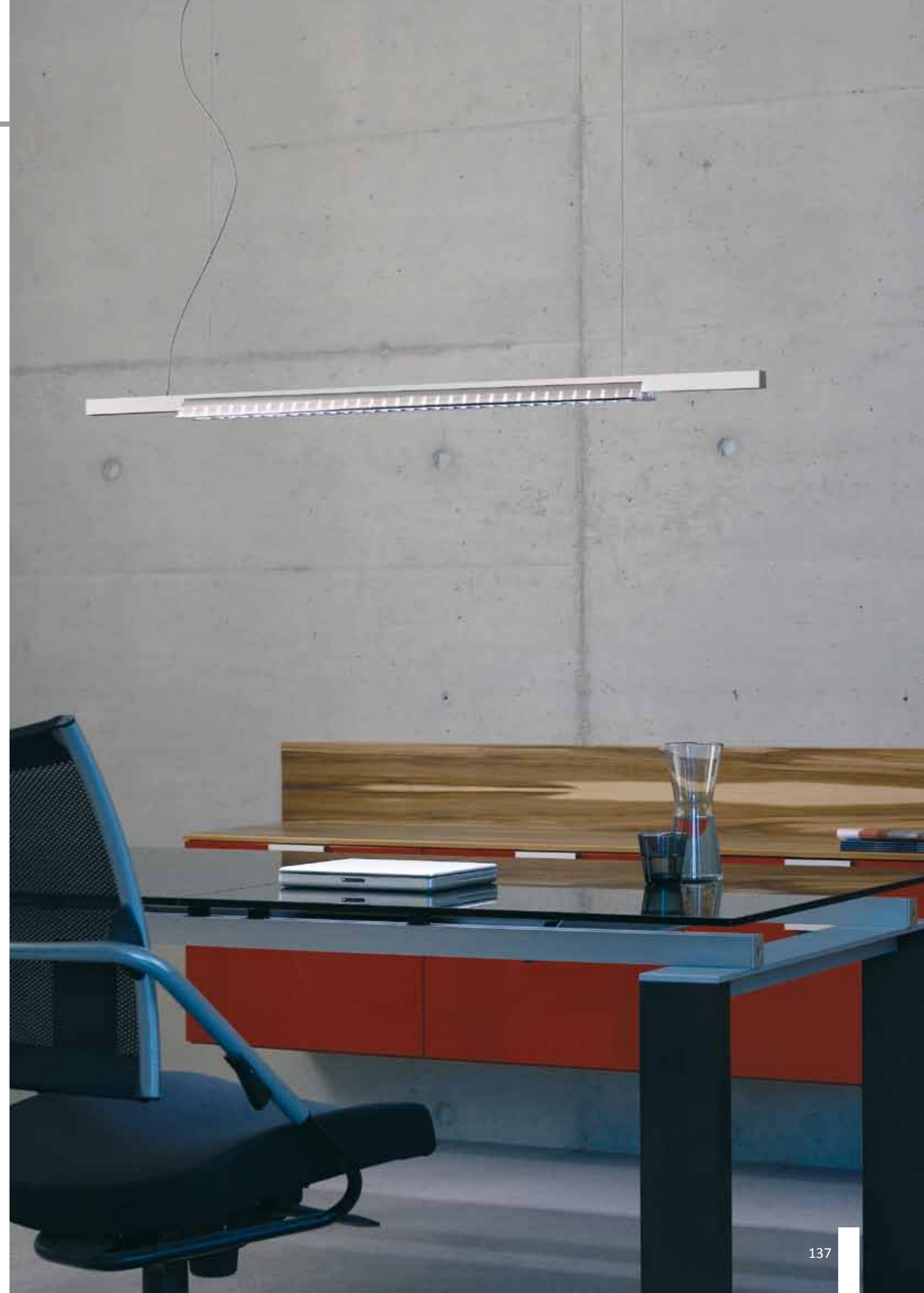
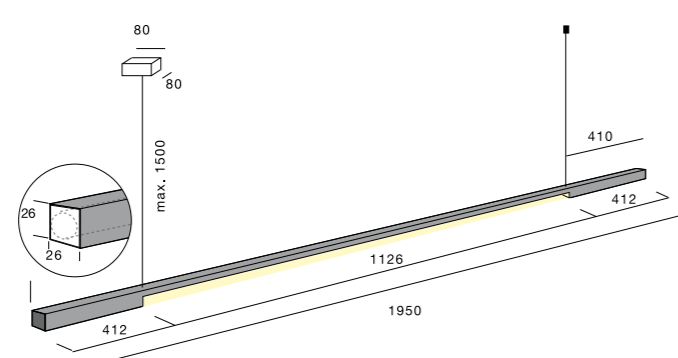

# MILANO NOTTE

Eccetto Hängeleuchte / Eccetto pendant

IP 20   

Geradlinige, direkt-/indirekt strahlende Hängeleuchte aus eloxiertem, stranggepresstem Aluminiumprofil, inkl. werkzeuglos höhenverstellbarer Seilauflhängung und Einspeisung. Optikvarianten: BAP-Raster 60° oder Opaldiffusor (separat ordern)

Straight-forward luminaire, direct / indirect lighting, made of anodised aluminium extrusion, suspension and power feed height toolless adjustable. Optional: 60° louvre or opal diffuser.



Apparecchio diretto / indiretto lineare in alluminio estruso anodizzato, Sospensione e alimentazione regolabili in altezza senza attrezzi. Opzionale: dark-light 60° o diffusore opale.

Appareil linéaire en aluminium extrudé anodisé, directe / indirecte, Les suspensions et l'alimentation sont réglable en hauteur sans outillage. Optionnel: dark-light 60° ou diffuseur opale.

Forma lineal en aluminio extruido anodizado, directo / indirecto. Las suspensiones y la alimentación son regulables en altura sin herramienta. Opcional: dark-light 60° o difusor ópalo.





BAP-Raster / darklight 60°

- 16-9021  1 x 21W
- 16-9024  1 x 24W
- 16-9054  1 x 54W



Opaldiffusor / Cover opal

- 16-9011  1 x 21W
- 16-9012  2 x 24W
- 16-9015  1 x 54W

2 x T16 · G5 · 230V · 21W · EVG

16-1116 

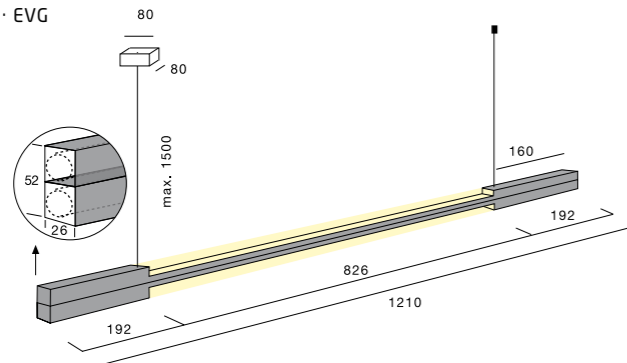

4 x T16 · G5 · 230V · 24W · EVG

16-1117 

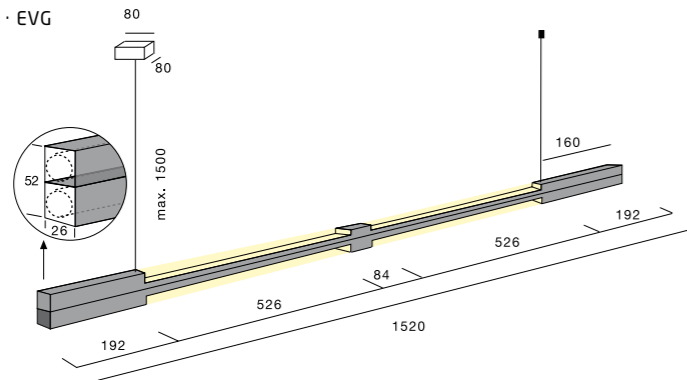

2 x T16 · G5 · 230V · 54W · EVG

16-1120 

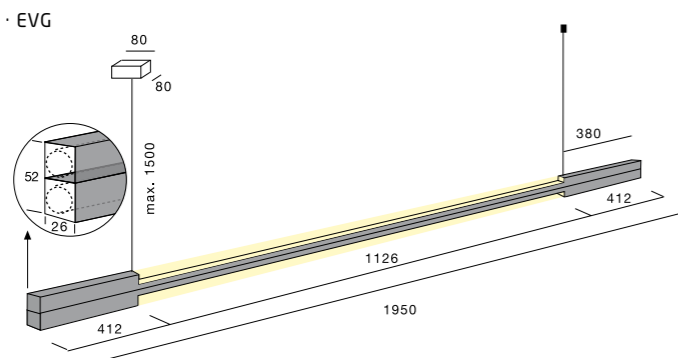

# MILANO NOTTE

Solo Hängeleuchte / Solo pendant

IP 20

Geradlinige, direktstrahlende Hängeleuchte aus eloxiertem, stranggepresstem Aluminiumprofil, inkl. werkzeuglos höhenverstellbarer Seilabhängung und Einspeisung. Optik: Opaldiffusor (separat ordern).

Straight-forward luminaire made of anodised aluminium extrusion, suspension and power feed height toolless adjustable. Optional: opal diffuser.

Apparecchio lineare in alluminio estruso anodizzato, Sospensione e alimentazione regolabili in altezza senza attrezzi. Opzionale: diffusore opale.

Appareil linéaire en aluminium extrudé anodisé, Les suspensions et l'alimentation sont réglable en hauteur sans outillage. Optionnel: diffuseur opale.

Forma lineal en aluminio extruido anodizado. Las suspensiones y la alimentación son regulables en altura sin herramienta. Opcional: difusor ópalo.

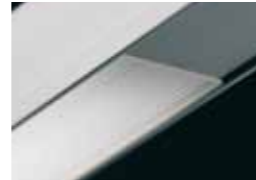

Opaldiffusor / Cover opal

- 16-9121 1 x 21W
- 16-9125 2 x 24W
- 16-9154 1 x 54W

1 x T16 · G5 · 230V · 21W · EVG

16-1011

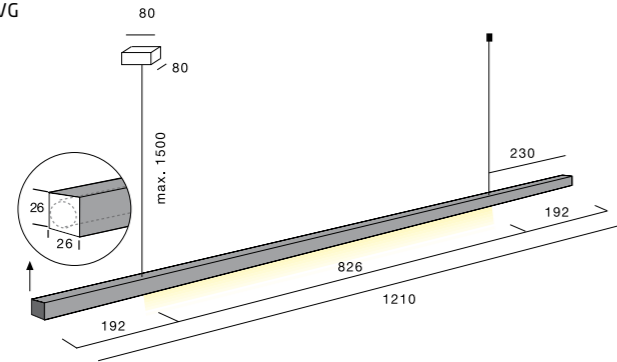

2 x T16 · G5 · 230V · 24W · EVG

16-1012

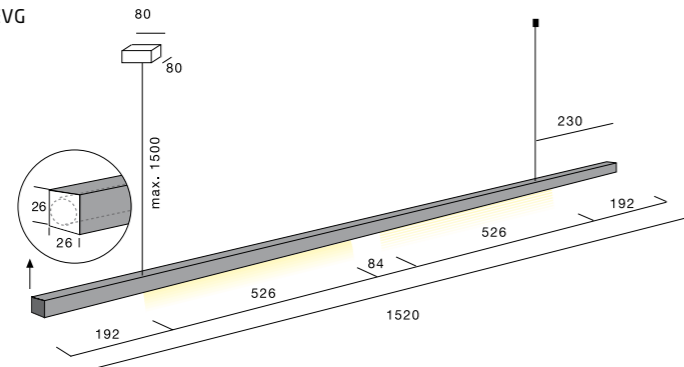

1 x T16 · G5 · 230V · 54W · EVG

16-1016

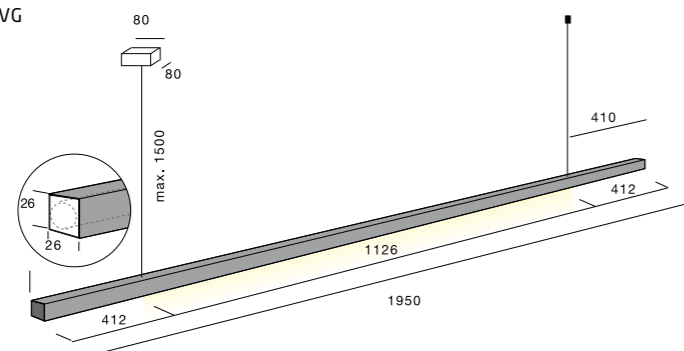

# MILANO NOTTE

Eccetto Wand- Deckenleuchte / Eccetto wall- ceiling luminaire

IP 20  

Geradlinige, direktstrahlende Wand- Deckenleuchte aus eloxiertem, stranggepresstem Aluminiumprofil, inkl. 2 Wandbefestigungen. Optikvarianten: BAP-Raster 60° oder Opaldiffusor (separat ordern).

Straight-forward luminaire made of anodised aluminium extrusion, two wall brackets included. Optional: 60° louvre or opal diffuser.



Apparecchio lineare in alluminio estruso anodizzato, compreso di due staffe a muro. Opzionale: dark-light 60° o diffusore opale.

Appareil linéaire en aluminium extrudé anodisé, avec deux supports pour le montage à mur. Optionnel: dark-light 60° ou diffuseur opale.

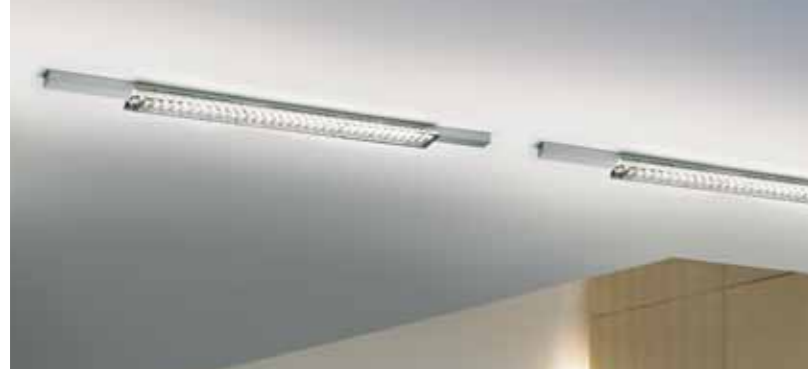
Forma lineal en aluminio extruido anodizado, con dos soportes de montaje a pared incluidos. Opcional: dark-light 60° o difusor ópalo.





BAP-Raster / darklight 60°

- 16-9021  1 x 21W
- 16-9024  1 x 24W
- 16-9054  1 x 54W



Opaldiffusor / Cover opal

- 16-9011  1 x 21W
- 16-9013  1 x 24W
- 16-9015  1 x 54W

1 x T16 · G5 · 230V · 21W · EVG

16-1421 

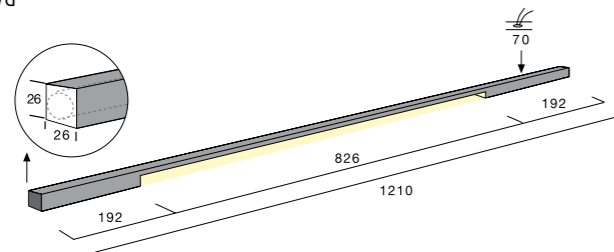

1 x T16 · G5 · 230V · 24W · EVG

16-1424 

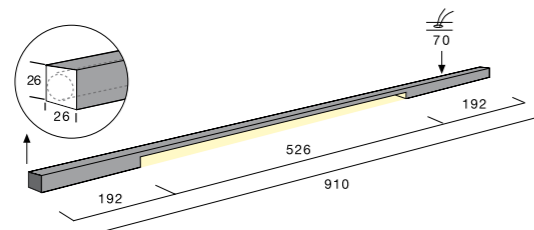

1 x T16 · G5 · 230V · 54W · EVG

16-1455 

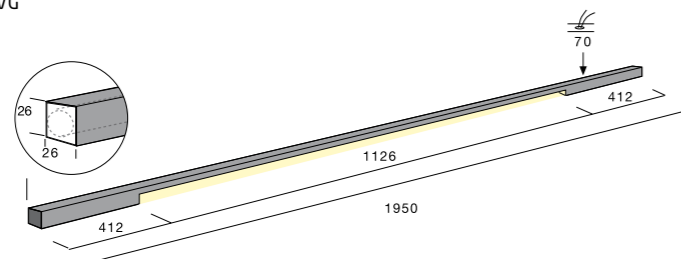

# MILANO NOTTE

Solo Wand- Deckenleuchte / Solo wall- ceiling luminaire

IP 20  

Geradlinige, direktstrahlende Wand- Deckenleuchte aus eloxiertem, stranggepresstem Aluminiumprofil, inkl. 2 Wandbefestigungen. Optik: Opaldiffusor (separat ordern)

Straight-forward luminaire made of anodised aluminium extrusion, two wall brackets included. Optional: opal diffuser.



Apparecchio lineare in alluminio estruso anodizzato, compreso di due staffe a muro. Opzionale: diffusore opale.

Appareil linéaire en aluminium extrudé anodisé, avec deux supports pour le montage à mur. Optionnel: diffuseur opale.

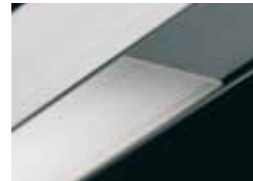
Forma lineal en aluminio extruido anodizado, con dos soportes de montaje a pared incluidos. Opcional: difusor ópalo.



Opaldiffusor / Cover opal

- 16-9121  1 x 21W
- 16-9124  1 x 24W
- 16-9154  1 x 54W

1 x T16 · G5 · 230V · 21W · EVG

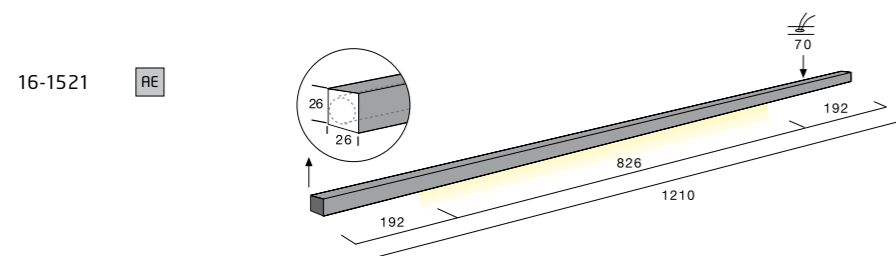

1 x T16 · G5 · 230V · 24W · EVG

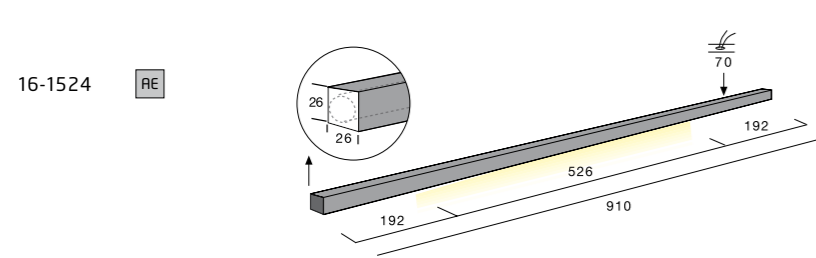

1 x T16 · G5 · 230V · 54W · EVG

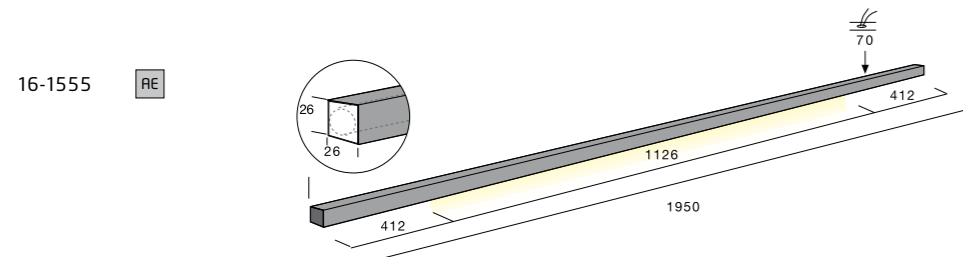

# MILANO NOTTE

Solo Wand- Deckenleuchte / Solo wall- ceiling luminaire

IP 20  

Geradlinige, direktstrahlende  
Wandleuchte aus eloxiertem,  
stranggepresstem Aluminium-  
profil, 90° schwenkbar, incl.  
Wandausleger. Optik: Opaldiffusor  
(separat ordern)

Straight-forward luminaire made  
of anodised aluminium extrusion,  
90° swivelling, wall-arm included.  
Optional: opal diffuser.



Apparecchio lineare in alluminio  
estruso anodizzato, orientabile  
90°, braccetti inclusi. Opzionale:  
diffusore opale.

Appareil linéaire en aluminium  
extrudé anodisé, orientable de  
90° avec console. Optionnel:  
diffuseur opale.

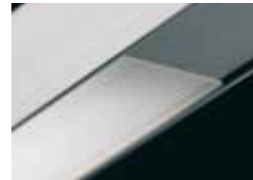
Forma lineal en aluminio extruido  
anodizado, orientable de 90°  
con brazos de pared incluidos.  
Opcional: difusor ópalo.



Opaldiffusor / Cover opal

- 16-9121  1 x 21W
- 16-9124  1 x 24W
- 16-9154  1 x 54W

1 x T16 · G5 · 230V · 21W · EVG

16-1321

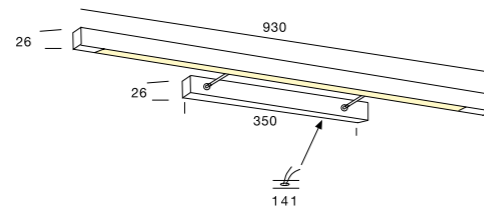
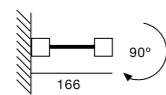

1 x T16 · G5 · 230V · 24W · EVG

16-1324

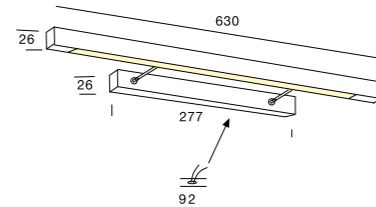

1 x T16 · G5 · 230V · 54W · EVG

16-1354

